

1 UNIT 3,5,7 BATHROOM
1 : 50 on A1 / 1 : 100 on A3

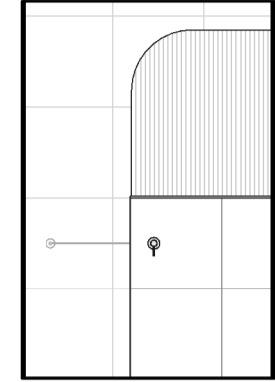

3.1 ELEVATION
1 : 50

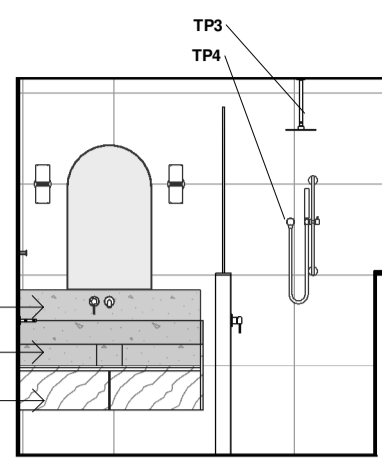

3.2 ELEVATION
1 : 50

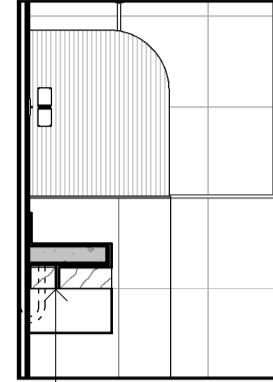

3.3 ELEVATION
1 : 50

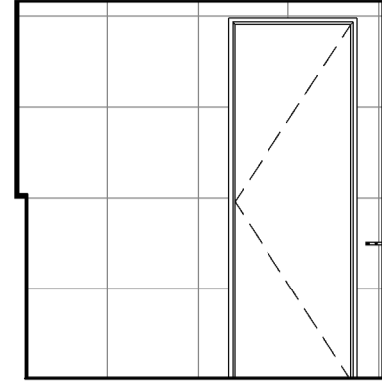

3.4 ELEVATION
1 : 50

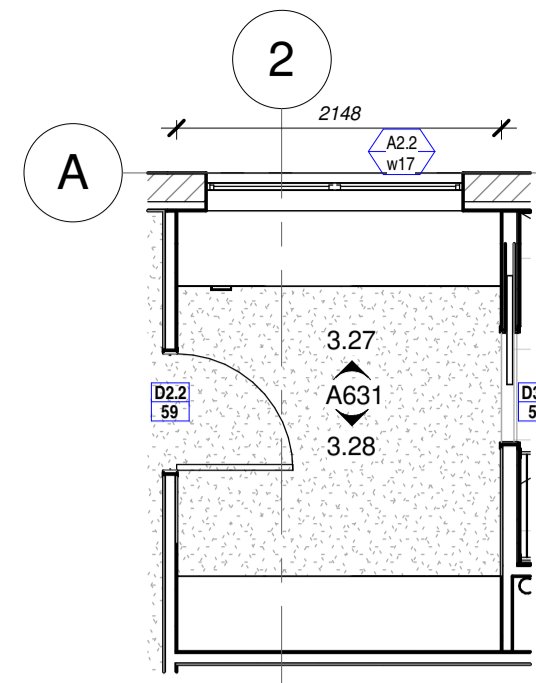

2 UNIT 3,5,7 ROBE 1
1 : 50 on A1 / 1 : 100 on A3

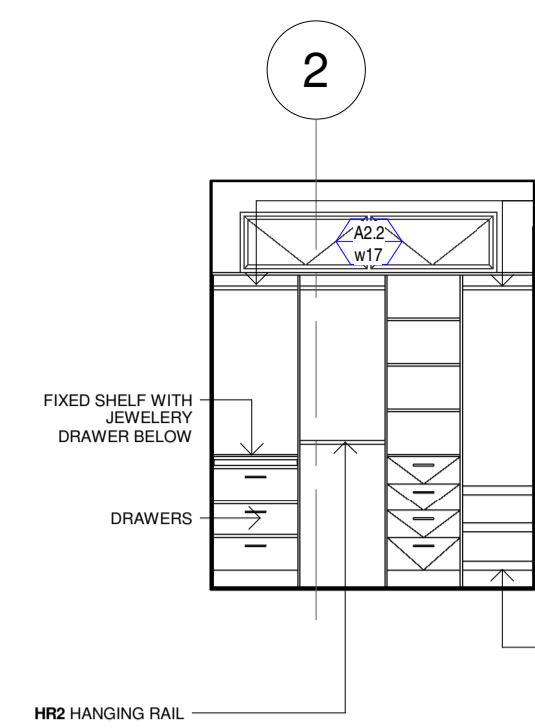

3.27 ELEVATION
1 : 50

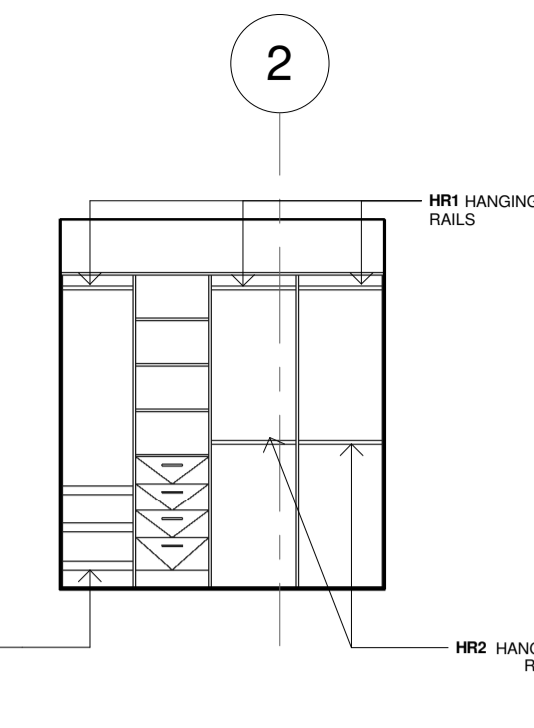

3.28 ELEVATION
1 : 50

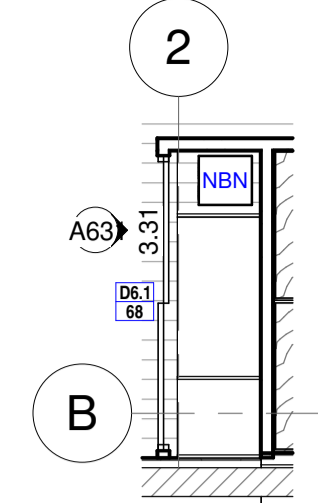

8 UNIT 3,5,7 STORE
1 : 50 on A1 / 1 : 100 on A3

ELEVATION
1 : 50

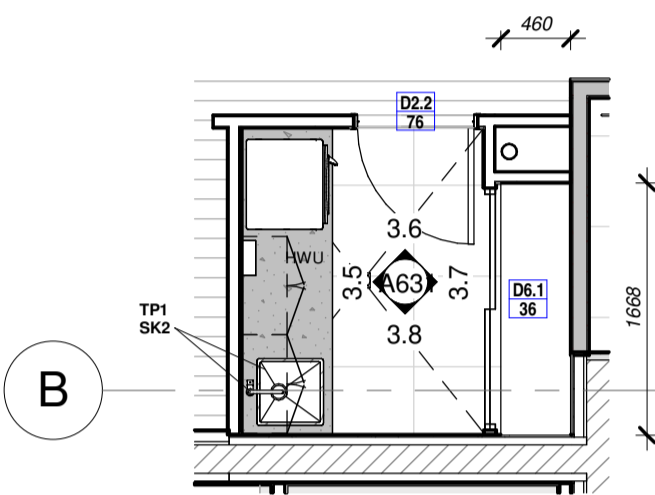

5 UNIT 3,5,7 LAUNDRY
1 : 50 on A1 / 1 : 100 on A3

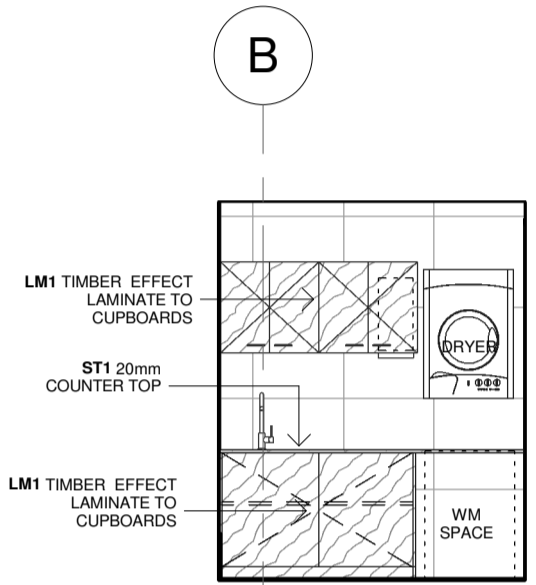

3.5 ELEVATION
1 : 50

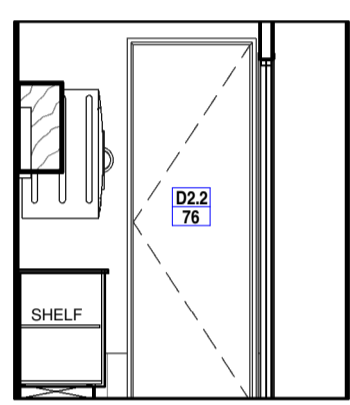

3.6 ELEVATION
1 : 50

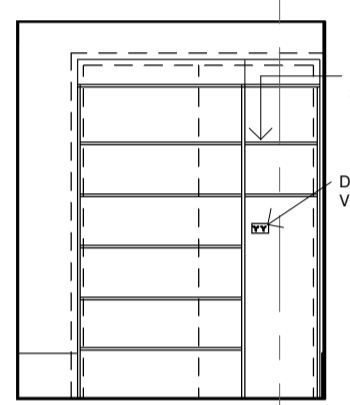

3.7 ELEVATION
1 : 50

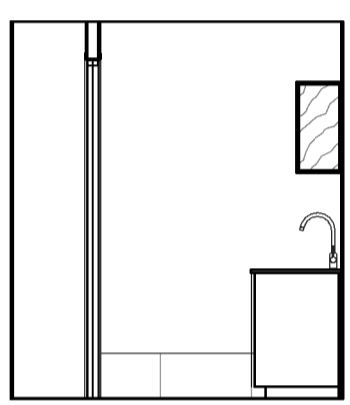

3.8 ELEVATION
1 : 50

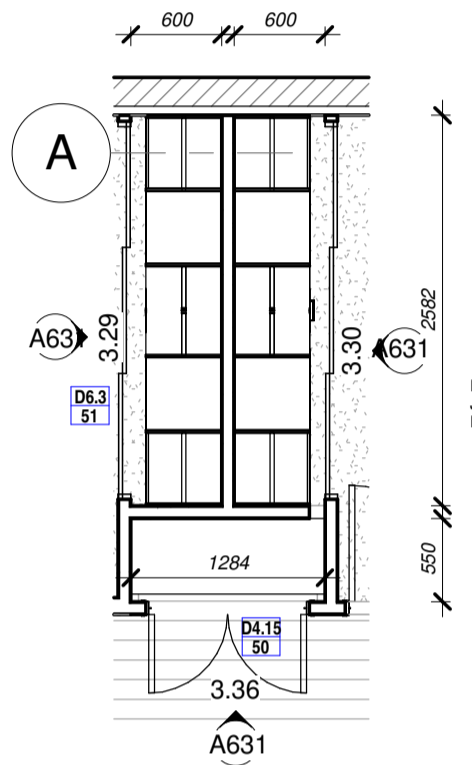

4 UNIT 3,5,7 ROBE 2
1 : 50 on A1 / 1 : 100 on A3

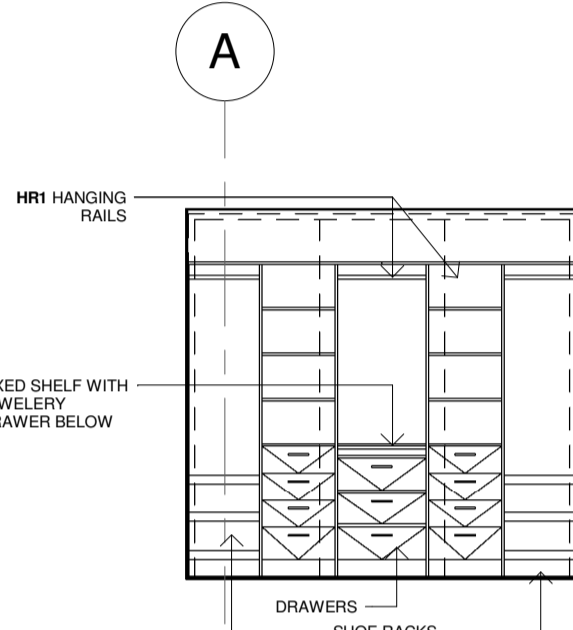

3.29 ELEVATION
1 : 50

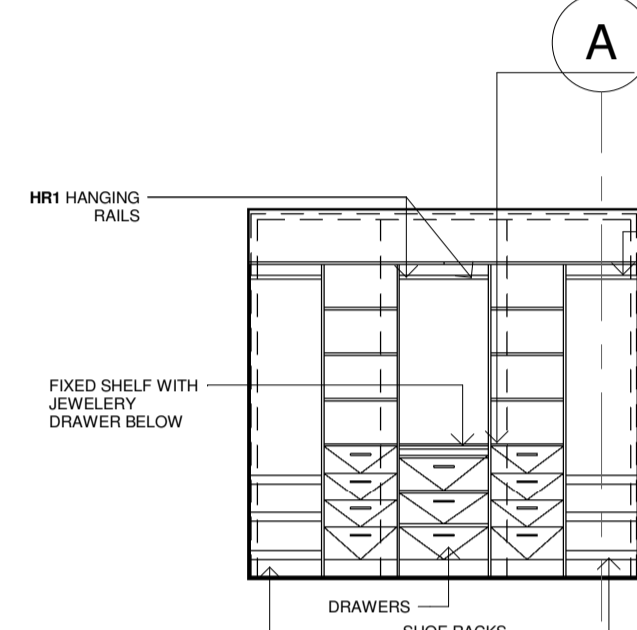

3.30 ELEVATION
1 : 50

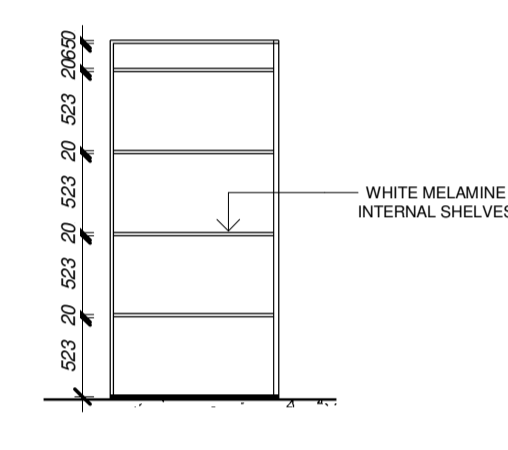

3.36 ELEVATION
1 : 50

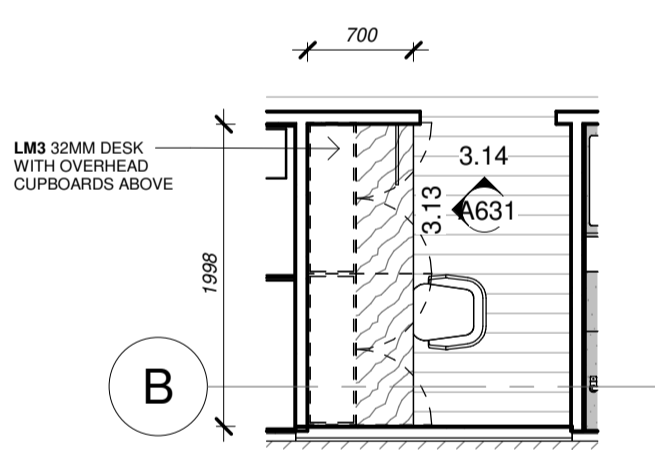

6 UNIT 3,7 STUDY
1 : 50 on A1 / 1 : 100 on A3

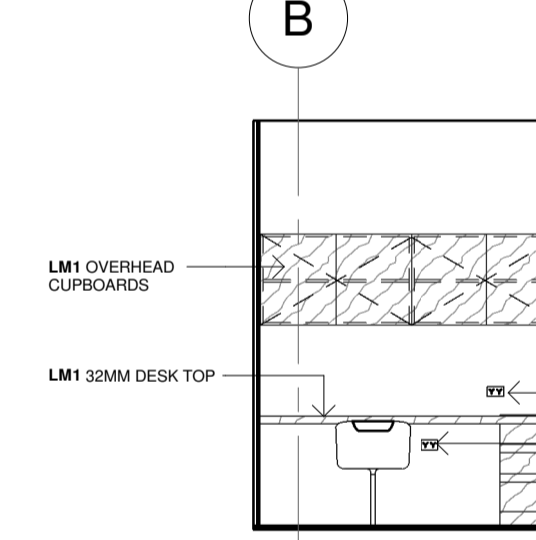

3.13 ELEVATION
1 : 50

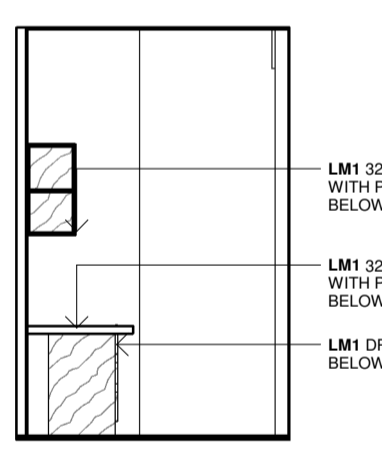

3.14 ELEVATION
1 : 50

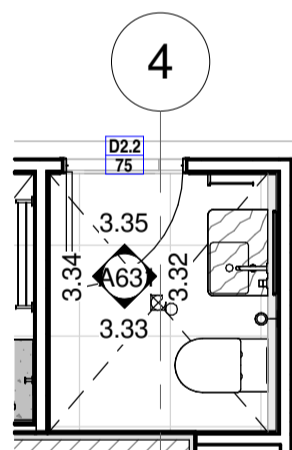

9 UNIT 3,5,7 POWDER
1 : 50 on A1 / 1 : 100 on A3

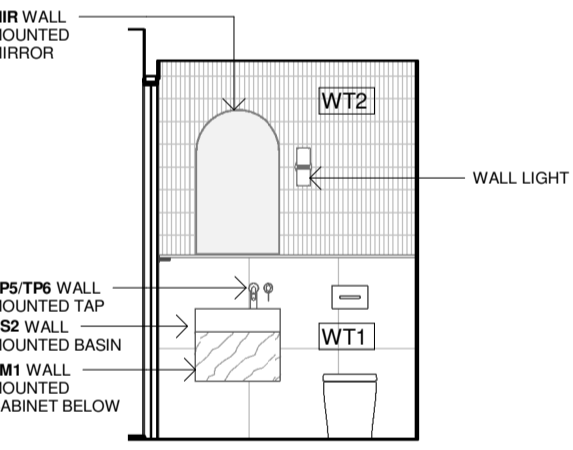

3.32 ELEVATION
1 : 50

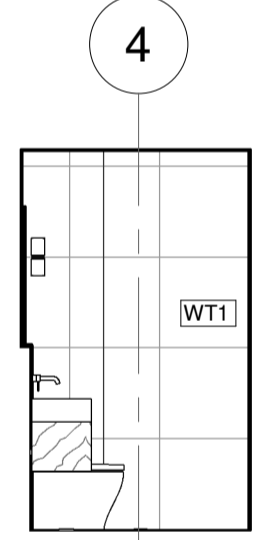

3.33 ELEVATION
1 : 50

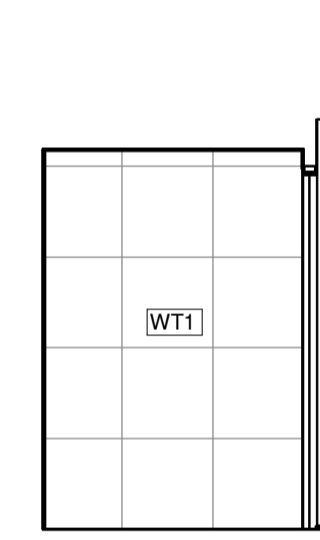

3.34 ELEVATION
1 : 50

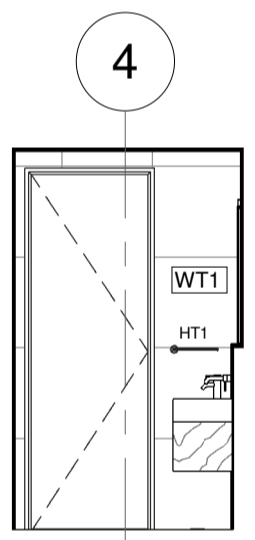

3.35 ELEVATION
1 : 50

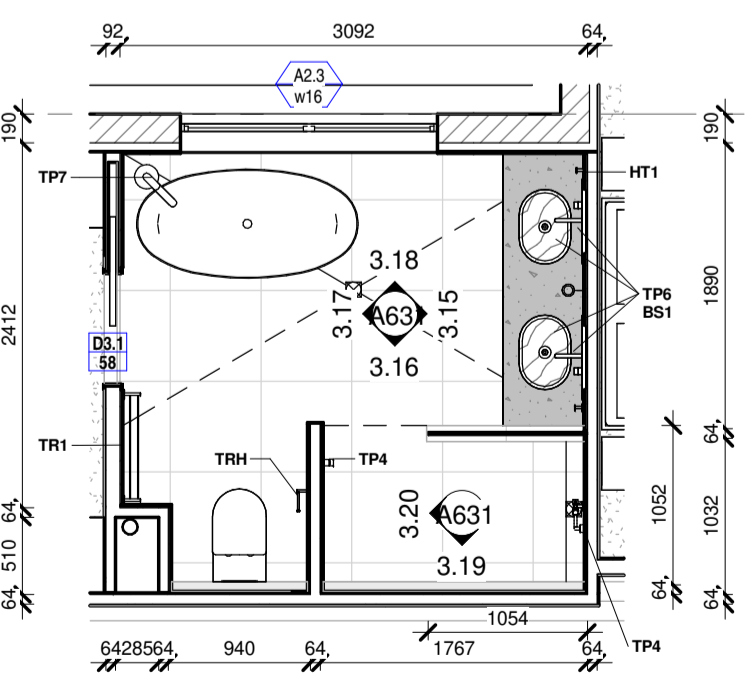

3 UNIT 3,5,7 ENSUITE
1 : 50 on A1 / 1 : 100 on A3

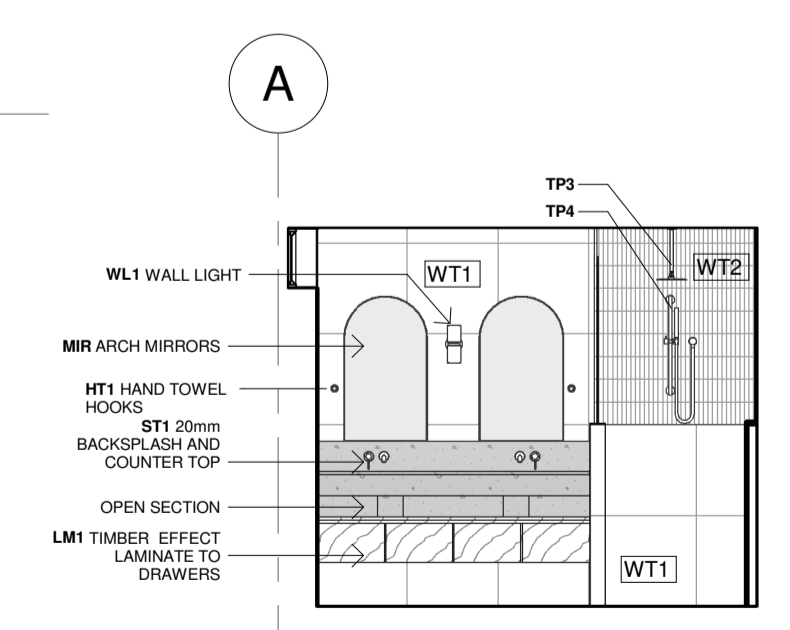

3.15 ELEVATION
1 : 50

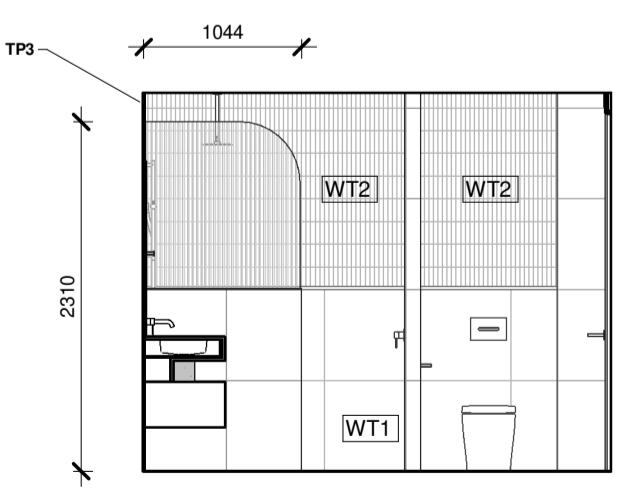

3.16 ELEVATION
1 : 50

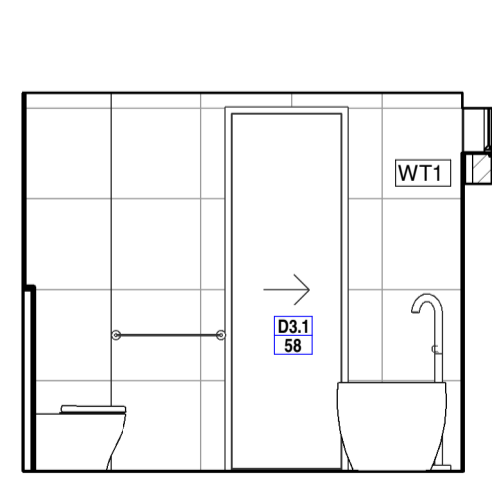

3.17 ELEVATION
1 : 50

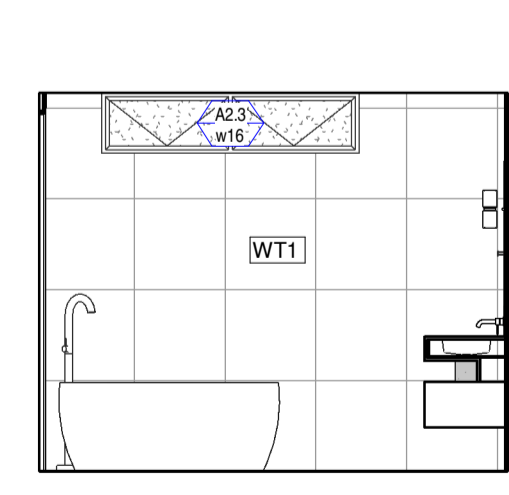

3.18 ELEVATION
1 : 50

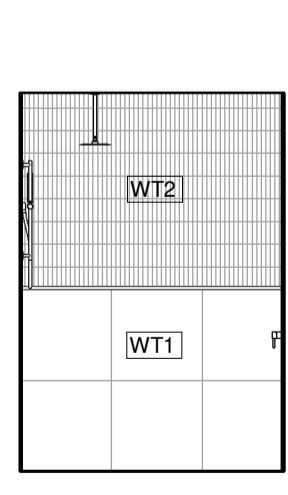

3.19 ELEVATION
1 : 50

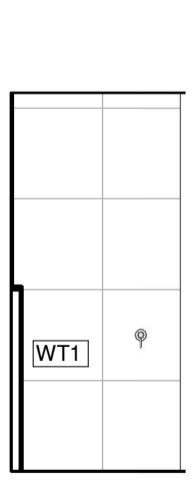

3.20 ELEVATION
1 : 50

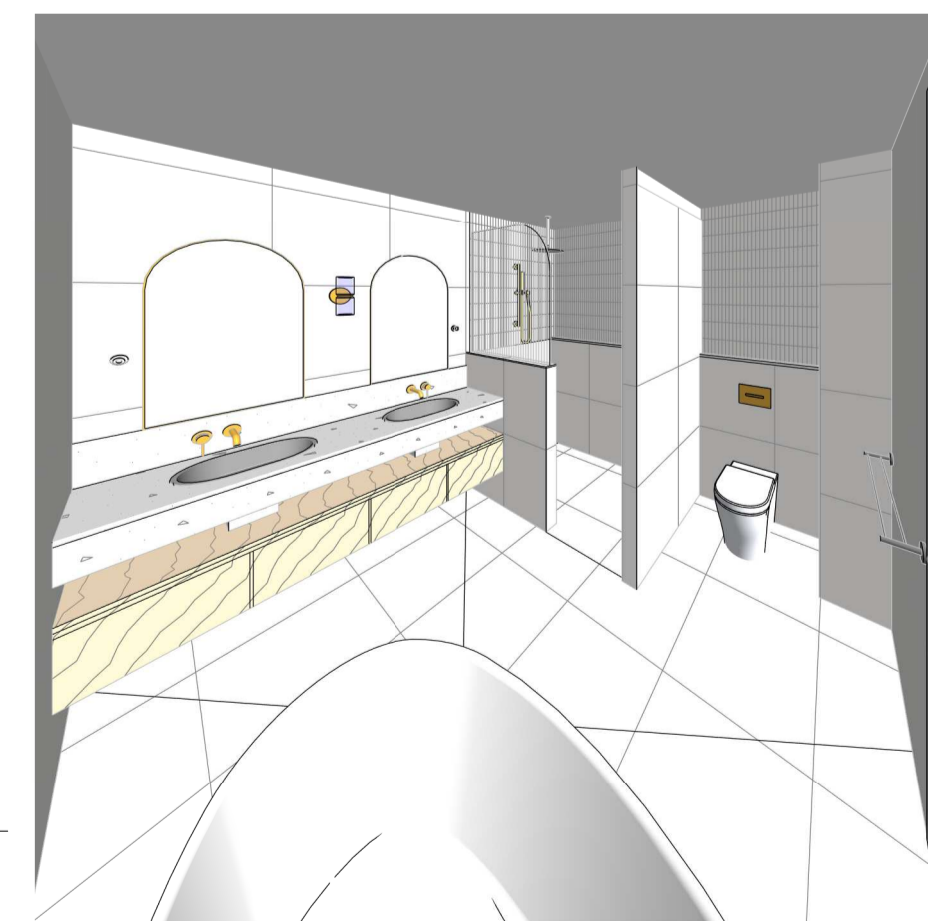

7 3D_U5 ENSUITE

FIXTURE LEGEND	
REFER TO FINISHES SCHEDULE FOR FULL SPEC INFO	
BA1	BATH TUB 1500L
BS1	BASIN - ALL VANITY COUNTERS
BS2	BASIN - WALL MOUNTED POWDER ROOMS
TP1	MIXER TAP - KITCHEN & BBQ
TP2	MIXER TAP - POWDER ROOMS
TP3	SHOWER HEAD - CEILING MOUNTED
TP4	HAND SHOWER RAIL - WALL MOUNTED
TP5	WALL MIXER - SHOWER
TP6	TAP - WALL MOUNTED ENSUITES/BATHROOMS
TP7	BATH TAP AND MIXER
SK1	DOUBLE SINK - UNDERBENCH KITCHEN
SK2/3	SINGLE 450 SINK - UNDERBENCH LAUNDRY/BBQ
SK4	SINGLE 610 SINK - UNDERBENCH BUTLERS PTY
MIR	ARCH MIRROR - WALL MOUNTED WET AREAS
WC1	TOILET - WALL FACED
CIS	CONCEALED CISTERN - ALL TOILETS
HD1	DOOR HANDLES
HG1	CABINERY HINGES
DG1	DRAWER GLIDES
HT1	HAND TOWEL HOOK
RB1	ROBE HOOK
TR1	DOUBLE TOWEL RAIL 850L
TR2	SINGLE TOWEL RAIL 850L
TR3	DOUBLE TOWEL RAIL 650L
TR4	SINGLE TOWEL RAIL 650L
TRH	TOILET ROLL HOLDER
WB1	DOUBLE WASTE BIN MECHANISM - KITCHENS
GR1	GLASS HANGER RAILS - CUSTOM LENGTHS
WR2	WALL MOUNTED WINE RACK
HR1	HANGING RAIL - PULL DOWN
6	PURCHASER VARIATION
5	FOR CONSTRUCTION
5	SCHEDULE CODES & UNIT 8 KITCHEN
4	CABINETS UPDATE
3	TENDER 2
2	CABINETS
1	TENDER 1
#	DESCRIPTION
	DATE

REVISION HISTORY	
FOR CONSTRUCTION	
ACN: 110893493 US - Level 1 - 70 Bay Terrace, WYNNUM QLD 4178 P.O. BOX 5129 MANLY QLD 4179 email: enquiries@thinktankarchitects.com.au phone: (07)3348 3727 / mobile: 0412 087 196	
These drawings are the copyright of THINK TANK Architects and are not to be reproduced in any way without the consent of THINK TANK Architects	
PROJECT	13-22
NEW RESIDENCES	
ADDRESS	121 SHORE ST N, CLEVELAND
CLIENT	BLANCA
ARCHITECT	MICHAEL JULLYAN
DRAWN	CHECKED
KP/ZS	MJ
ISSUE	
CONSTRUCTION	
SHEET TITLE	
UNIT 3, 5, 7 CABINETS	
SHEET NUMBER	REV
A631	B
REV DATE	27.02.2026